

嵌入式系統暨無線網路實驗室  
Embedded Systems and Wireless Networking Lab  
(News Lab)

逢愛君 教授

網頁：<http://www.csie.ntu.edu.tw/~acpang/>

E-mail: [acpang@csie.ntu.edu.tw](mailto:acpang@csie.ntu.edu.tw)

實驗室：台大資訊系(德田館) R438室

# 無線網路實驗室 (FGCN Lab, R438)

指導教授: 逢愛君 (Ai-Chun Pang) 教授 (2010~present)

- ◆ 台灣大學電機資訊學院副院長 (2019~present)
- ◆ 台灣大學資訊網路與多媒體研究所所長 (2013-2016)
- ◆ 台灣大學資訊工程系暨資訊網路與多媒體研究所副教授 (2005-2010)
- ◆ 台灣大學資訊工程系暨資訊網路與多媒體研究所助理教授 (2002-2005)

研究領域:

- ◆ Wireless Network Communications
- ◆ Mobile Computing and Performance Modeling
- ◆ Software-Defined Networking (SDN)
- ◆ Fog/Edge Computing
- ◆ Internet of Things (IoT)

# 實驗室成員

## 2019年實驗室成員：

- ◆ 博士班：2位
- ◆ 碩士班：11位
- ◆ 在職碩/博班：2位
- ◆ 專題生：4位

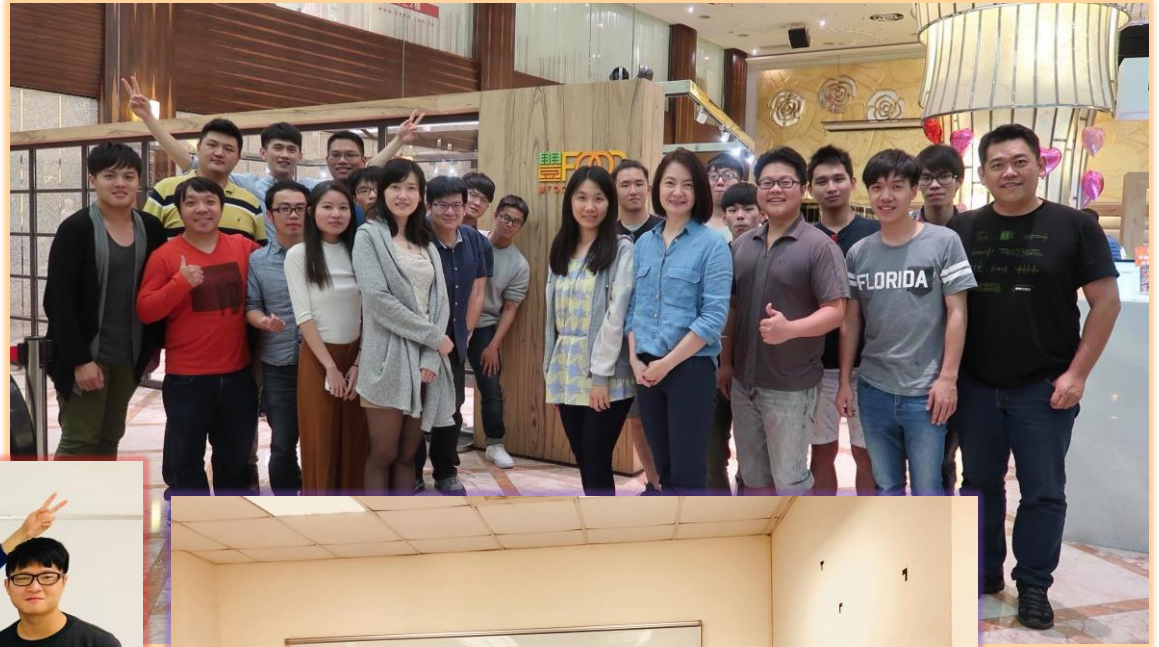

# 實驗室簡介

- 實驗室(R438)同仁們為人數眾多的一個大家族，碩班跟博班分布比例大約各佔一半，目前同學們的研究主要針對無線網路領域比較具重要性或者前瞻性議題為主，例如：
  - ◆ 5G and Next-Generation Mobile Networks
  - ◆ Software-Defined Networking (SDN)
  - ◆ Fog/Edge Computing
  - ◆ Internet of Things (IoT)
- 實驗室氣氛融洽，每年定期會舉辦出遊、中秋烤肉、運動會、小畢典、謝師宴等活動，另外也常會一起聚餐，培養同學們之間的情誼，遇到有同學生日更是會有溫馨的慶生活動，充滿驚喜，感受大家的熱情。
- 心動不如馬上行動，歡迎您成為我們實驗室的一份子！

# 前瞻研究

## ◆ 研究成果論文發表(僅列出2017-2018年)

### ◆ 國際期刊論文 (Journal)

- [1] Y.-Y. Shih, W.-H. Chung, A.-C. Pang, T.-C. Chiu and H.-Y. Wei, "Enabling Low-Latency Applications in Fog-Radio Access Networks," in *IEEE Network*, vol. 31, no. 1, pp. 52-58, January 2017.
- [2] T.-C. Chiu, Y.-Y. Shih, A.-C. Pang and C.-W. Pai, "Optimized Day-Ahead Pricing With Renewable Energy Demand-Side Management for Smart Grids," in *IEEE Internet of Things Journal*, vol. 4, no. 2, pp. 374-383, April 2017
- [3] S.-F. Chou, Y.-J. Yu and A.-C. Pang, "Mobile Small Cell Deployment for Service Time Maximization Over Next-Generation Cellular Networks," in *IEEE Transactions on Vehicular Technology*, vol. 66, no. 6, pp. 5398-5408, June 2017.
- [4] Y.-Y. Shih, A.-C. Pang and P.-C. Hsiu, "A Doppler Effect-Based Framework for Wi-Fi Signal Tracking in Search and Rescue Operations," in *IEEE Transactions on Vehicular Technology*, vol. 67, no. 5, pp. 3924-3936, May 2018.
- [5] H.-P. Lin, Y.-Y. Shih, A.-C. Pang, and C.-T. Chou, "Virtual Local-Hub: A Service Platform on the Edge of Networks for Wearable Devices," accepted to appear in *IEEE Network*, 2018
- [6] Y.-Y. Shih, P.-C. Hsiu and A.-C. Pang, "A Data Parasitizing Scheme for Effective Health Monitoring in Wireless Body Area Networks," accepted to appear in *IEEE Transactions on Mobile Computing*, 2018

### ◆ 國際會議論文 (International Conference)

- [1] A.-C. Pang, W.-H. Chung, T.-C. Chiu and J. Zhang, "Latency-Driven Cooperative Task Computing in Multi-user Fog-Radio Access Networks," in *IEEE International Conference on Distributed Computing Systems (ICDCS)*, Atlanta, 2017, pp. 615-624.
- [2] S.-F. Chou, H.-W. Yen, Y.-J. Chen, A.-C. Pang and T.-W. Ho, "Coverage Maximization with Switched Multi-Element Antennas in Next Generation Cellular Networks," in *IEEE Vehicular Technology Conference (VTC-Fall)*, Toronto, 2017, pp. 1-5.
- [3] Y.-J. Yu, T.-C. Chiu, A.-C. Pang, M.-F. Chen and J.-Liu, "Virtual machine placement for backhaul traffic minimization in fog radio access networks," in *IEEE International Conference on Communications (ICC)*, Paris, 2017, pp. 1-7.
- [4] S.-F. Chou, Y.-J. Yu, A.-C. Pang, and T.-A. Lin, "Energy-Aware 3D Aerial Small-Cell Deployment over Next Generation Cellular Networks," accepted to appear in *IEEE Vehicular Technology Conference (VTC-Spring)*, Porto, 2018.





# Ultra Low Latency Realization in 5G

In order to realize the latency of several ms, new technology will be required.

*“Push everything to the edge of network for low latency”*

## Cloud Computing



- Centralized pooling
- Efficient resource utilization

## Fog Computing



- Close to the edge
- Low latency

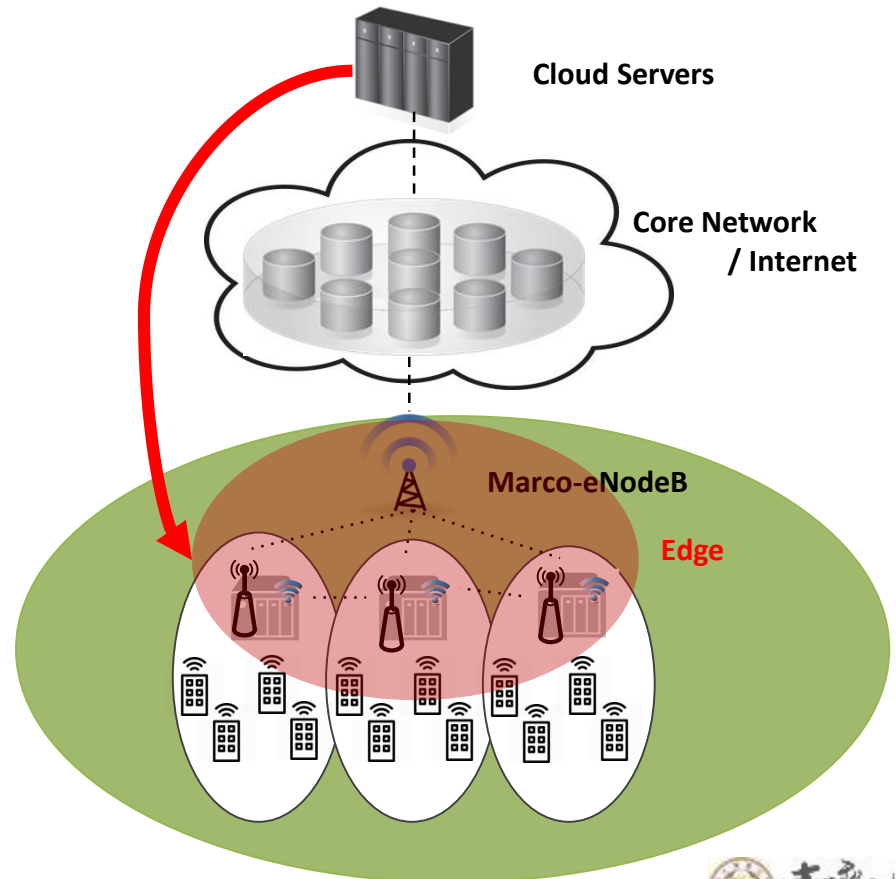

# Fog-Radio Access Network (F-RAN)

- **Equipment in the RAN**

- responsible for both **communication** (protocol/signaling) and **application services** (data processing and storage)
- can communicate with each other directly via existing or advanced network technologies

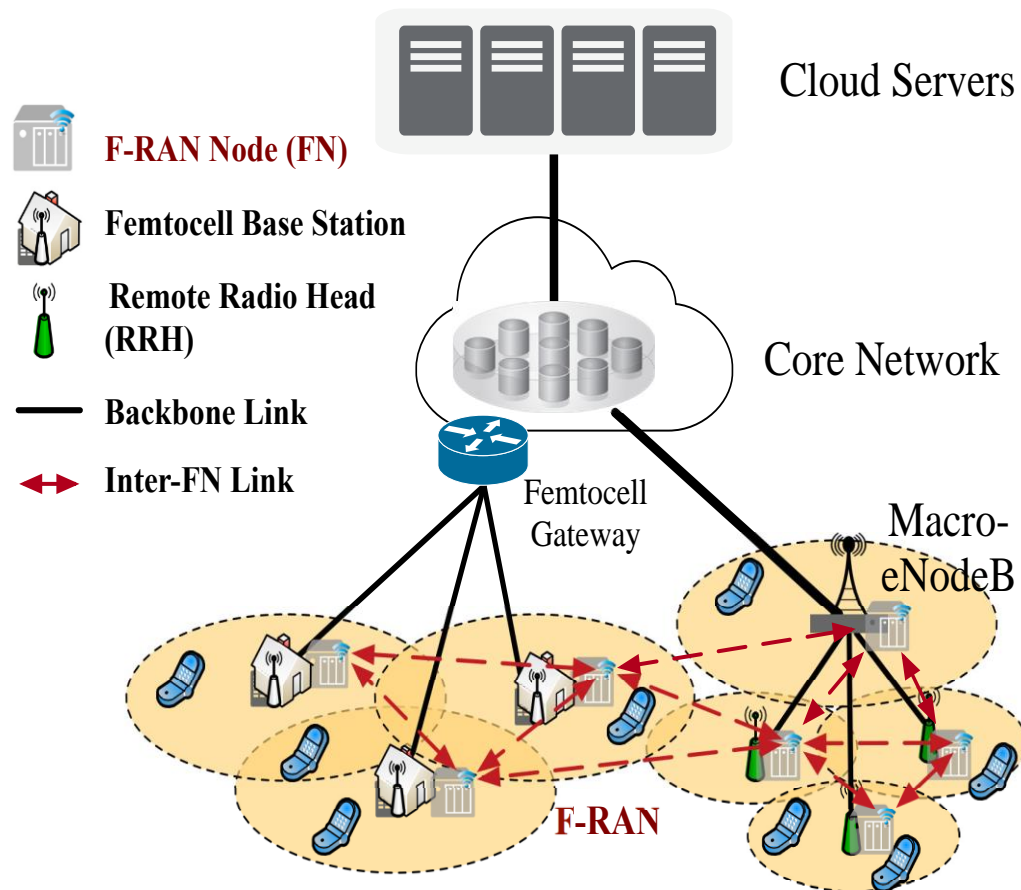

# How F-RAN Works

## Reduce Communication Delay

- **WAN latency** is hard to improve
- Some applications require **bulk processing data** for computing-intensive tasks (e.g., real-time video analytics )

## Reduce Computing Delay

- Distribute **computing-intensive tasks** to multiple edge nodes

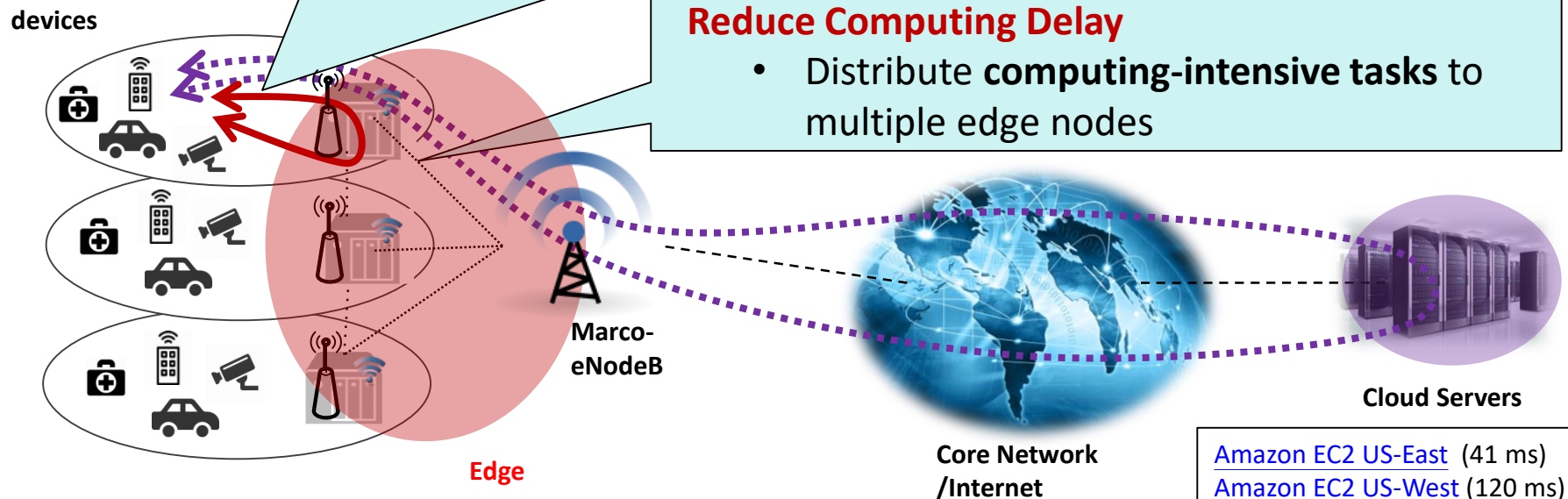

[Amazon EC2 US-East](#) (41 ms)  
[Amazon EC2 US-West](#) (120 ms)  
[Amazon EC2 EU](#) (190ms)  
[Amazon EC2 Asia](#) (320ms)

End-to-End Latency Measurement by CMU from a Youtube client



# Software-Defined Networking (SDN)

➔ SDN is an emerging network architecture

- ❑ Decoupling of control and data planes
- ❑ Directly Programmable network
- ❑ Logically centralizing network intelligence



**Management Plane:**  
**Logically-centralized control**

**Control Plane: Distributed algorithms (i.e., OSPF)**

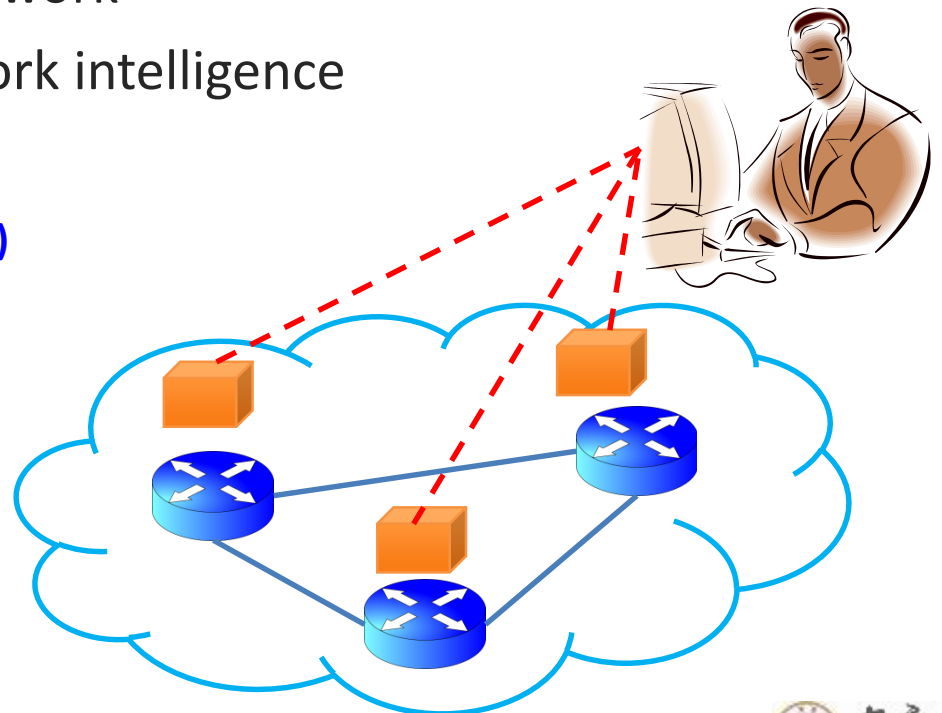
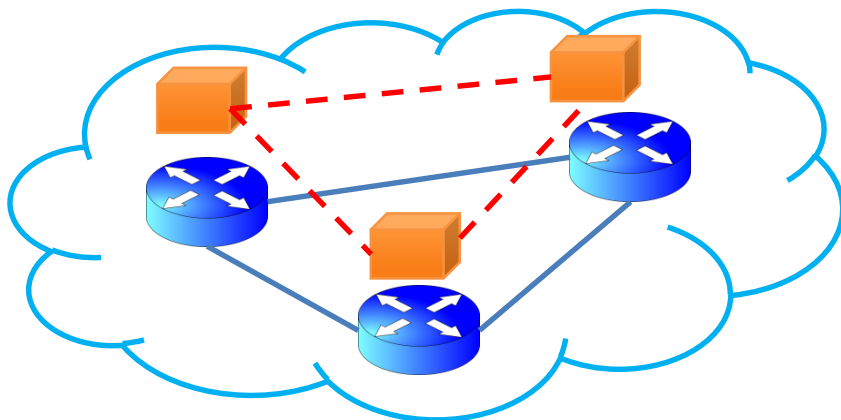

# Research Issues in SDN

- Controller Scalability
- Network update
- Traffic Management
- Security
- Middleboxes

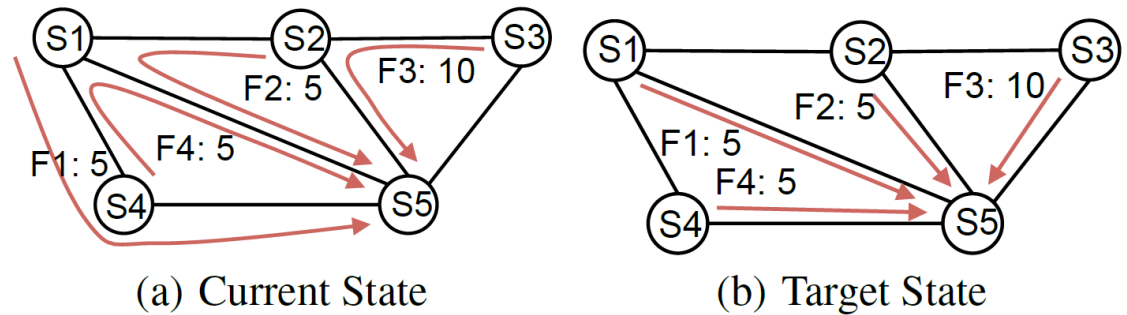

Network update example by Dionysus

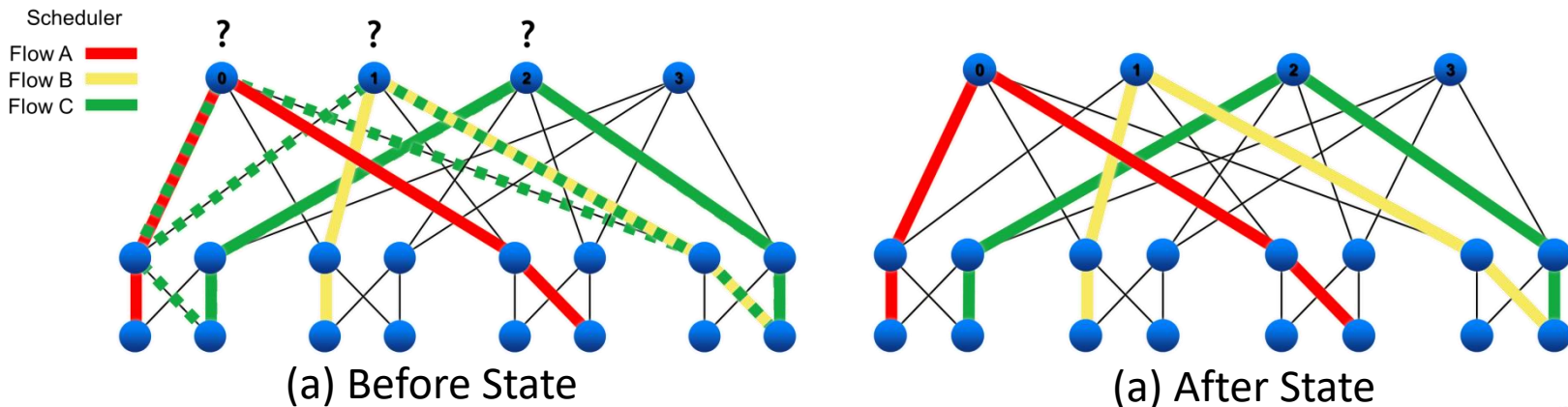

Traffic management example by Hedera

# SDN Hybrid Transmission Platform: Traffic Load Balancing

- Technical Features
  - Hybrid transmissions
    - Wired and wireless links
  - Traffic load balancing
  - Multipath routing

網路流量  
(byte)

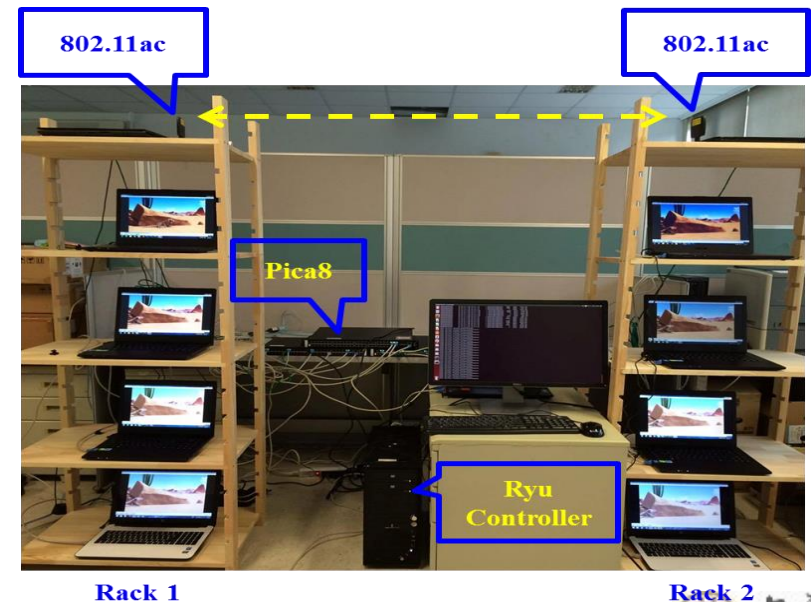
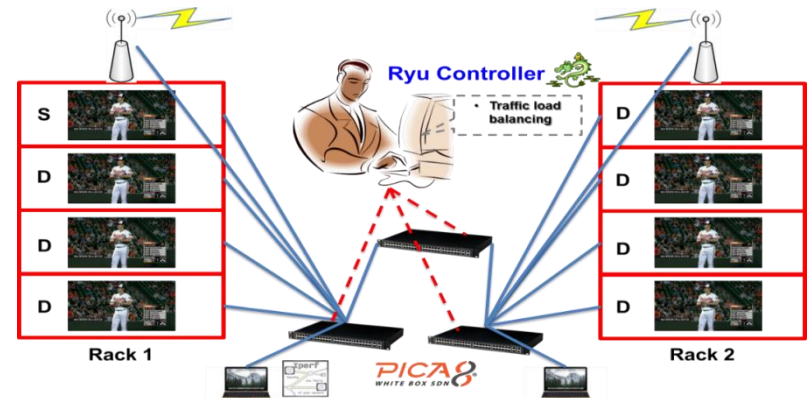
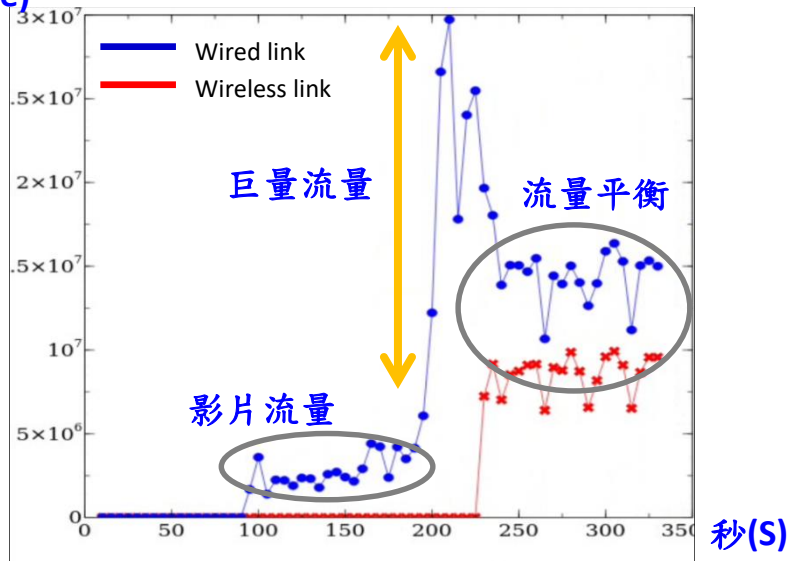

# 執行中計畫

科技部

Ministry of Science and Technology

◆ 科技部：

- ◆ 計畫名稱：支援低延遲應用之霧端無線接取網路
- ◆ 計畫名稱：實現智能物聯網之綠能霧端通訊與運算台波國合計畫：為未來資通訊永續發展之霧端通訊、運算與控制設計
- ◆ 價創計畫：OmniEyes-次世代行動影像平台



◆ 產學合作單位：

- ◆ 工業技術研究院 (Industrial Technology Research Institute)
  - 計畫名稱: 支援無人機在農損辨識應用之行動網緣運算



# 實驗室活動



中秋節烤肉



歷屆畢業生回lab聚餐



爬象山



貓空



小畢業典



謝師宴



# 溫馨慶生會





# 每年定期舉辦運動會



運動會開幕



籃球



羽毛球



排球



桌球



運動會閉幕

# 近年實驗室成員獲獎紀錄

- ◆ 賀!逢老師榮獲107年度「**科技部傑出研究獎**」!
- ◆ 賀!林心鵬同學榮獲2019年「**斐陶斐榮譽會員**」!
- ◆ 賀!周詩梵同學榮獲2018年資訊學會「**最佳博士論文獎優選**」!
- ◆ 賀!邱德泉同學榮獲2018年「**斐陶斐榮譽會員**」、「**台大優秀青年**」、資訊學會「**最佳博士論文獎佳作**」!
- ◆ 賀!逢老師及 OmniEyes 團隊榮獲2019年「**CES 創新獎**」!
- ◆ 賀!顏修溫、周詩梵同學以及逢老師榮獲2018年第14屆無線、隨意及感測網路研討會「**最佳論文獎**」!
- ◆ 賀!謝天然同學榮獲2017年第22屆行動計算研討會「**最佳報告獎**」!
- ◆ 賀!周詩梵同學榮獲2017年資訊學會「**卓鑫淼資訊學生領袖獎**」及「**斐陶斐榮譽會員**」!
- ◆ 賀!施淵耀同學榮獲2016年資訊學會「**博士論文優等獎**」!
- ◆ 賀!余亞儒、葉名祐同學以及逢老師榮獲2016年第21屆行動計算研討會「**最佳論文獎**」!
- ◆ 賀!許佑嘉、王志勝、周詩梵同學以及逢老師、邱碧貞、張述傑榮獲2014年WASN「**最佳人氣獎**」!
- ◆ 賀!周詩梵同學榮獲2013年「**Google Taiwan Anita Borg Scholarship**」!
- ◆ 賀!李昇穆、王志勝、李官翰、葉家榮榮獲2013年「**原住民族部落觀光APP大賽優選**」!
- ◆ 賀!邱德泉同學榮獲2012年資訊學會「**最佳碩士論文獎佳作**」!

# 畢業生出路

## 博士班畢業生：（更新至2019年）

- ◆ 國立中興大學副教授：學文
- ◆ 國立高雄大學助理教授：亞儒
- ◆ 國立中正大學助理教授：淵耀
- ◆ 自行創業：昱凱
- ◆ 趨勢科技：浩民
- ◆ 中華電信：心鵬
- ◆ 中央研究院博士後研究員：詩梵、德泉
- ◆ 科技部博士後研究員：清智

## 碩士班畢業生：（更新至2019年）

- ◆ 聯發科技(10位)：冠昌、彥德、堂德、精為、羽婷、偉漢、志勝、明汎、楊勛、修溫
- ◆ 台積電(5位)：博仁、萬泉、千漢、孟揚、名祐
- ◆ 群暉科技(5位)：治顯、哲瑋、士恩、仁忠、冠宇
- ◆ 中華電信(5位)：榮財、薇卉、宏穎、中岑、依芳
- ◆ 群聯電子(3位)：欣駿、官翰、宣浦
- ◆ 國防部 (3位)：翁瑋、捷生、泓宇
- ◆ 智易科技(2位)：乃碩、維德
- ◆ 瑞昱科技(2位)：佑嘉、昇穆
- ◆ 四零四科技(1位)：子賢
- ◆ 訊連科技(1位)：紹偉
- ◆ 威聯通(1位)：梓暘
- ◆ 絡達科技(1位)：凱暉
- ◆ 普安科技(1位)：若芸
- ◆ 慧容科技(1位)：元耀
- ◆ 資策會(1位)：柏寬
- ◆ 中國公司(1位)：偉傑
- ◆ 智財局(1位)：博翔

# R438實驗室相關資訊

## 招生訊息

- ◆ 實驗室成員每年固定會收4~6位碩士班新生
- ◆ 博士班新生則沒有限制

## Group Meeting時間

- ◆ 目前為每週一上午11:00-12:00，在德田館R542舉行

## 如何加入實驗室？

- ◆ 同學可以直接到R438找實驗室同學詢問
- ◆ 有意願加入的同學，可寄信與逢老師約時間面談  
([acpang@csie.ntu.edu.tw](mailto:acpang@csie.ntu.edu.tw))

歡迎對無線網路領域有熱忱的同學加入我們這個大家族!